

HW-F850

# Crystal Surround Air Track (Active Speaker System) user manual

imagine the possibilities

Thank you for purchasing this Samsung product.  
To receive more complete service, please register  
your product at

[www.samsung.com/register](http://www.samsung.com/register)

**SAMSUNG**

# features

---

## **SoundShare**

SoundShare produces TV sound on your SAT via a Bluetooth connection and controls the sound.

## **HDMI**

HDMI transmits video and audio signals simultaneously, and provides a clearer picture.

The unit is also equipped with the ARC function which lets you listen to sound from your TV via an HDMI cable through the Crystal Surround Air Track. This function is only available if you connect the unit to an ARC compliant TV.

## **3D Sound Plus**

The 3D SOUND PLUS feature adds depth and spaciousness to your listening experience.

## **Wireless Subwoofer**

Samsung's wireless module does away with cables running between the main unit and the subwoofer.

Instead, the subwoofer connects to a compact wireless module that communicates with the main unit.

## **Special Sound mode**

You can select from 7 different sound modes - MUSIC, NEWS, DRAMA, CINEMA, SPORTS, GAME, and STANDARD (Original Sound) - depending on the type of content you want to enjoy.

## **Multi-function Remote Control**

The supplied remote control can be used to control the TV connected to this unit. (Works only for Samsung TVs)

The remote control has a TV hotkey that enables you to perform various operations with the simple press of a button.

## **Active Speaker System**

This unit features an Active Speaker System that provides high sound quality in a single slim unit. This unit does not require any satellite loudspeakers or speaker cabling, which are normally associated with conventional surround sound systems.

## **USB Host support**

You can connect and play music files from external USB storage devices such as MP3 players, USB flash memory, etc. using the Air Track's USB HOST function.

## **Bluetooth Function**

You can use connect a Bluetooth device to the SAT and enjoy music with high quality stereo sound, all without wires!

## **NFC**

Connect your NFC compatible device via Bluetooth to the AirTrack using this simple set-up procedure and play music on the device through the AirTrack.

## **LICENSE**

---



Manufactured under license from Dolby Laboratories. Dolby and the double-D symbol are trademarks of Dolby Laboratories.



Manufactured under license under U.S. Patent Nos: 5,956,674; 5,974,380; 6,487,535 & other U.S. and worldwide patents issued & pending. DTS, the Symbol, & DTS and the Symbol together are registered trademarks & DTS 2.0 Channel is a trademark of DTS, Inc. Product includes software. © DTS, Inc. All Rights Reserved.





The terms HDMI and HDMI High-Definition Multimedia Interface, and the HDMI Logo are trademarks or registered trademarks of HDMI Licensing LLC in the United States and other countries.

- To send inquiries and requests regarding open sources, contact Samsung via Email ([oss.request@samsung.com](mailto:oss.request@samsung.com)).

# safety information

## SAFETY WARNINGS

TO REDUCE THE RISK OF ELECTRIC SHOCK, DO NOT REMOVE THE COVER (OR BACK). NO USER-SERVICEABLE PARTS ARE INSIDE. REFER SERVICING TO QUALIFIED SERVICE PERSONNEL.

	<div style="text-align: center;"> <p><b>CAUTION</b></p> <p>RISK OF ELECTRIC SHOCK DO NOT OPEN</p> </div>	
<p>The lightning flash and arrowhead within the triangle indicates that there is dangerous voltage inside the product.</p>	<p><b>CAUTION:</b> TO REDUCE THE RISK OF ELECTRIC SHOCK, DO NOT REMOVE THE COVER (OR BACK). NO USER SERVICEABLE PARTS INSIDE. REFER SERVICING TO QUALIFIED SERVICE PERSONNEL.</p>	<p>The explanation point within the triangle indicates that there are important instructions accompanying the product.</p>

### WARNING

- To reduce the risk of fire or electric shock, do not expose this appliance to rain or moisture.
- To prevent injury, this apparatus must be securely attached to the floor/wall in accordance with the installation instructions.

### CAUTION

- Do not expose this apparatus to dripping or splashing. Do not put objects filled with liquids, such as vases on the apparatus.
- To turn this apparatus off completely, you must pull the power plug out of the wall socket. Consequently, the power plug must be easily and readily accessible at all times.

This product satisfies FCC regulations when shielded cables and connectors are used to connect the unit to other equipment. To prevent electromagnetic interference with electric appliances, such as radios and televisions, use shielded cables and connectors for connections.

### FCC NOTE (for U.S.A.):

This equipment has been tested and found to comply with the limits for a Class B digital device, pursuant to Part 15 of the FCC Rules. These limits are designed to provide reasonable protection against harmful interference in a residential installation.

This equipment generates, uses and can radiate radio frequency energy and, if not installed and used in accordance with the instructions, may cause harmful interference to radio communications. However, there is no guarantee that interference will not occur in a particular installation.

If this equipment does cause harmful interference to radio or television reception, which can be determined by turning the equipment off and on, the user is encouraged to try to correct the interference by one or more of the following measures:

- Reorient or relocate the receiving antenna.
- Increase the separation between the equipment and receiver.
- Connect the equipment to an outlet that is on a different circuit than the radio or TV.
- Consult the dealer or an experienced radio/TV technician for help.

Caution : FCC regulations state that any unauthorized changes or modifications to this equipment may void the user's authority to operate it.

## Important Safety Instructions

Read these operating instructions carefully before using the unit. Follow all the safety instructions listed below. Keep these operating instructions handy for future reference.

- Read these instructions.
- Keep these instructions.
- Heed all warnings.
- Follow all instructions.
- Do not use this apparatus near water.
- Clean only with dry cloth.
- Do not block any ventilation openings. Install in accordance with the manufacturer's instructions.
- Do not install near any heat sources such as radiators, heat registers, stoves, or other apparatus (including amplifiers) that produce heat.
- Do not defeat the safety purpose of the polarized or grounding-type plug. A polarized plug has two blades with one wider than the other. A grounding type plug has two blades and a third grounding prong. The wide blade or the third prong are provided for your safety. If the provided plug does not fit into your outlet, consult an electrician for replacement of the obsolete outlet.
- Protect the power cord from being walked on or pinched particularly at plugs, convenience receptacles, and the point where they exit from the apparatus.
- Only use attachment/accessories specified by the manufacturer.
- Use only with the cart, stand, tripod, bracket, or table specified by the manufacturer, or sold with the apparatus. When a cart is used, use caution when moving the cart/apparatus combination to avoid injury from tip-over.
- Unplug this apparatus during lightning storms or when unused for long periods of time.
- Refer all servicing to qualified service personnel. Servicing is required when the apparatus has been damaged in any way, such as power-supply cord or plug is damaged, liquid has been spilled or objects have fallen into the apparatus, the apparatus has been exposed to rain or moisture, does not operate normally, or has been dropped.



# PRECAUTIONS

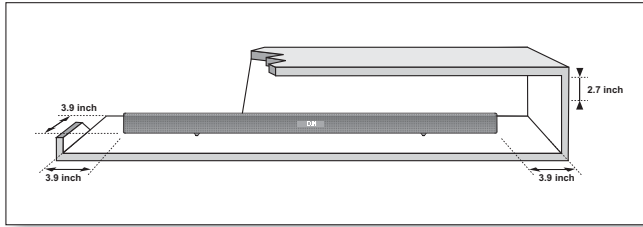

Ensure that the AC power supply in your house complies with the power requirements listed on the identification sticker located on the back of your product. Install your product horizontally, on a suitable base (furniture), with enough space around it for ventilation (3-4 inches). Make sure the ventilation slots are not covered. Do not place the unit on amplifiers or other equipment which may become hot. This unit is designed for continuous use. To fully turn off the unit, disconnect the AC plug from the wall outlet. Unplug the unit if you intend to leave it unused for a long period of time.



During thunderstorms, disconnect the AC plug from the wall outlet. Voltage peaks due to lightning could damage the unit.

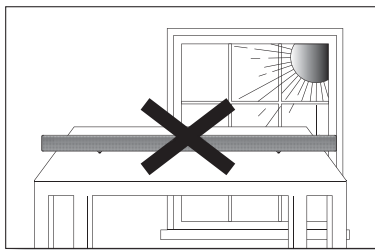

Do not expose the unit to direct sunlight or other heat sources. This could lead to overheating and cause the unit to malfunction.

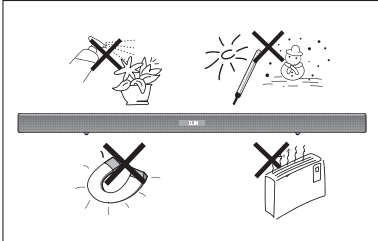

Protect the product from moisture (i.e. vases), and excess heat (e.g. a fireplace) or equipment creating strong magnetic or electric fields. Disconnect the power cable from the AC supply if the unit malfunctions. Your product is not intended for industrial use. It is for personal use only.

Condensation may occur if your product has been stored in cold temperatures. If transporting the unit during the winter, wait approximately 2 hours until the unit has reached room temperature before using.

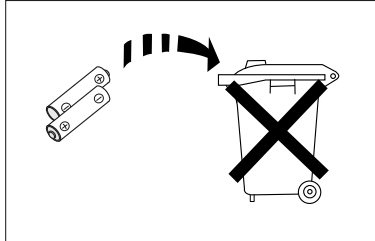

The batteries used with this product contain chemicals that are harmful to the environment. Do not dispose of batteries in the general household trash.



<b>FEATURES</b>	2	Features
	2	License
<b>SAFETY INFORMATION</b>	3	Safety warnings
	4	Precautions
<b>GETTING STARTED</b>	6	Before reading the user's manual
	6	What's included
<b>DESCRIPTIONS</b>	7	Front/Bottom panel
	8	Rear Panel
<b>REMOTE CONTROL</b>	9	Tour of the remote control
<b>CONNECTIONS</b>	10	Installing the wall mount
	11	Connecting the wireless subwoofer
	12	Attaching the toroidal ferrite core to the power cord of the subwoofer
	12	Looping the power cable around the toroidal core
	12	Auto sound calibration
	13	Connecting an external device using an HDMI cable
	14	Connecting an external device using Audio (analog) cable or Optical (digital) cable
	14	Assembling the cable clip
<b>FUNCTIONS</b>	15	Input mode
	15	ARC (HDMI out)
	16	NFC
	17	Bluetooth
	19	SoundShare
	20	USB
	21	Using the remote control
	24	Software upgrade
<b>TROUBLESHOOTING</b>	25	Troubleshooting
<b>APPENDIX</b>	26	Specifications

# getting started

## BEFORE READING THE USER'S MANUAL

Note the following terms before reading the user manual.

### Icons used in this manual

Icon	Term	Definition
	<b>Caution</b>	Indicates a situation where a function does not operate or settings may be canceled.
	<b>Note</b>	Indicates tips or instructions on the page that help you operate a function.

### Safety Instructions and Troubleshooting

- 1) Be sure to familiarize yourself with the Safety Instructions before using this product. (See page 3)
- 2) If a problem occurs, check Troubleshooting. (See page 25)







### Copyright

©2013 Samsung Electronics Co.,Ltd.

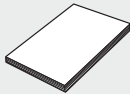
All rights reserved; no part of this user's manual may be reproduced or copied without the prior written permission of Samsung Electronics Co.,Ltd.

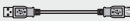
## WHAT'S INCLUDED

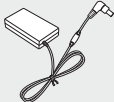
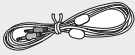
Check for the supplied accessories shown below.

			<ul style="list-style-type: none"> <li>● (Holder-screw:2EA)</li> <li>● (Screw:2EA)</li> </ul>		
<b>Remote Control / Batteries (AAA size)</b> (AH59-02583A/ 4301-000116)	<b>User Manual</b> (AH68-02655A)	<b>Bracket-Wall Mount</b> (AH61-03408A)	<b>Screw</b> (AH61-03342A/ 6001-001961)	<b>USB Cable</b> (AH39-01178B)	<b>Cable Clip</b> (AH65-00012B)
				(For Subwoofer power cable 1EA) 	
<b>Power Cord</b> (3903-000598)	<b>DC Adapter</b> (BN44-00639B)	<b>AUX Cable</b> (BN39-01286A)	<b>ASC Microphone</b> (AH59-02570A)	<b>Toroidal ferrite core</b> (3301-000144)	



- The appearance of the accessories may differ slightly from the illustrations above.
- Use the dedicated USB cable to connect external USB devices to the unit.

## FRONT/BOTTOM PANEL

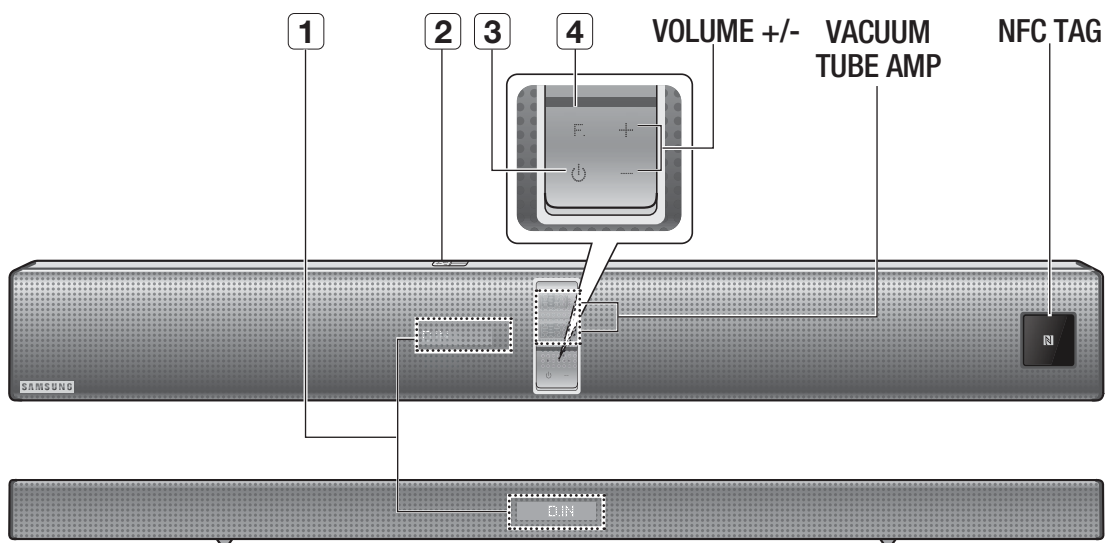

<p><b>1</b> <b>DISPLAY</b></p>	<p>Displays the current mode.</p> <ul style="list-style-type: none"> <li>- If there is no input from the product or remote control for 15 seconds, the display will turn off automatically.</li> <li>- The display will not turn off automatically in BT READY, TV READY and USB Playing modes.</li> </ul>
<p><b>2</b> <b>USB PORT</b></p>	<p>Connect USB devices such as MP3 players here to play files on the devices.</p>
<p><b>3</b> <b>POWER BUTTON</b></p>	<p>Turns the Crystal Surround Air Track on and off.</p>
<p><b>4</b> <b>FUNCTION BUTTON</b></p>	<p>Selects the D.IN, AUX, HDMI, BT, TV, USB input.</p> <ul style="list-style-type: none"> <li>- While the unit is powered on, pressing the (F.) button for more than 3 seconds converts the button to the <b>MUTE</b> (M) button. To cancel <b>MUTE</b> (M) button setup, press the (F.) button for more than 3 seconds again.</li> </ul>



- When you turn on this unit, there will be a 4 to 5 second delay before it produces sound.
- Do not bring cellular phones or mobile devices near the vacuum tube amp, or put other electronic devices on the top of the product. Signals from these devices can cause noise or distortion in the audio.
- Do not let children touch the product's surface when the set is on. It will be hot.

# descriptions

## REAR PANEL

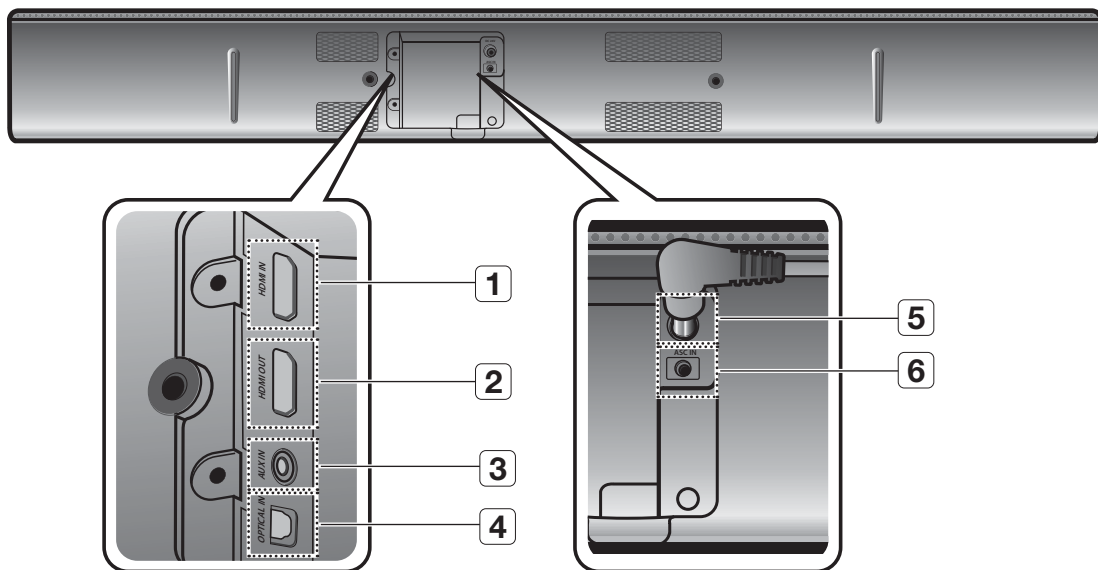

<b>1 HDMI IN JACK</b>	Receives digital video and audio signals simultaneously from an external source using an HDMI cable.
<b>2 HDMI OUT JACK</b>	Outputs digital video and audio signals simultaneously using an HDMI cable.
<b>3 AUX IN</b>	Connect to the Analog output of an external device.
<b>4 OPTICAL IN</b>	Connect to the digital (optical) output of an external device.
<b>5 POWER SUPPLY IN</b>	Connect the AC power adaptor jack to the power supply jack, and then connect the AC power adaptor plug to a wall outlet.
<b>6 ASC IN JACK</b>	Used to connect the ASC Microphone.

- !** When disconnecting the power cable of the AC power adaptor from the wall outlet, pull the plug. Do not pull the cable.
- Do not connect this unit or other components to an AC outlet until all connections between components are complete.



# remote control

## TOUR OF THE REMOTE CONTROL

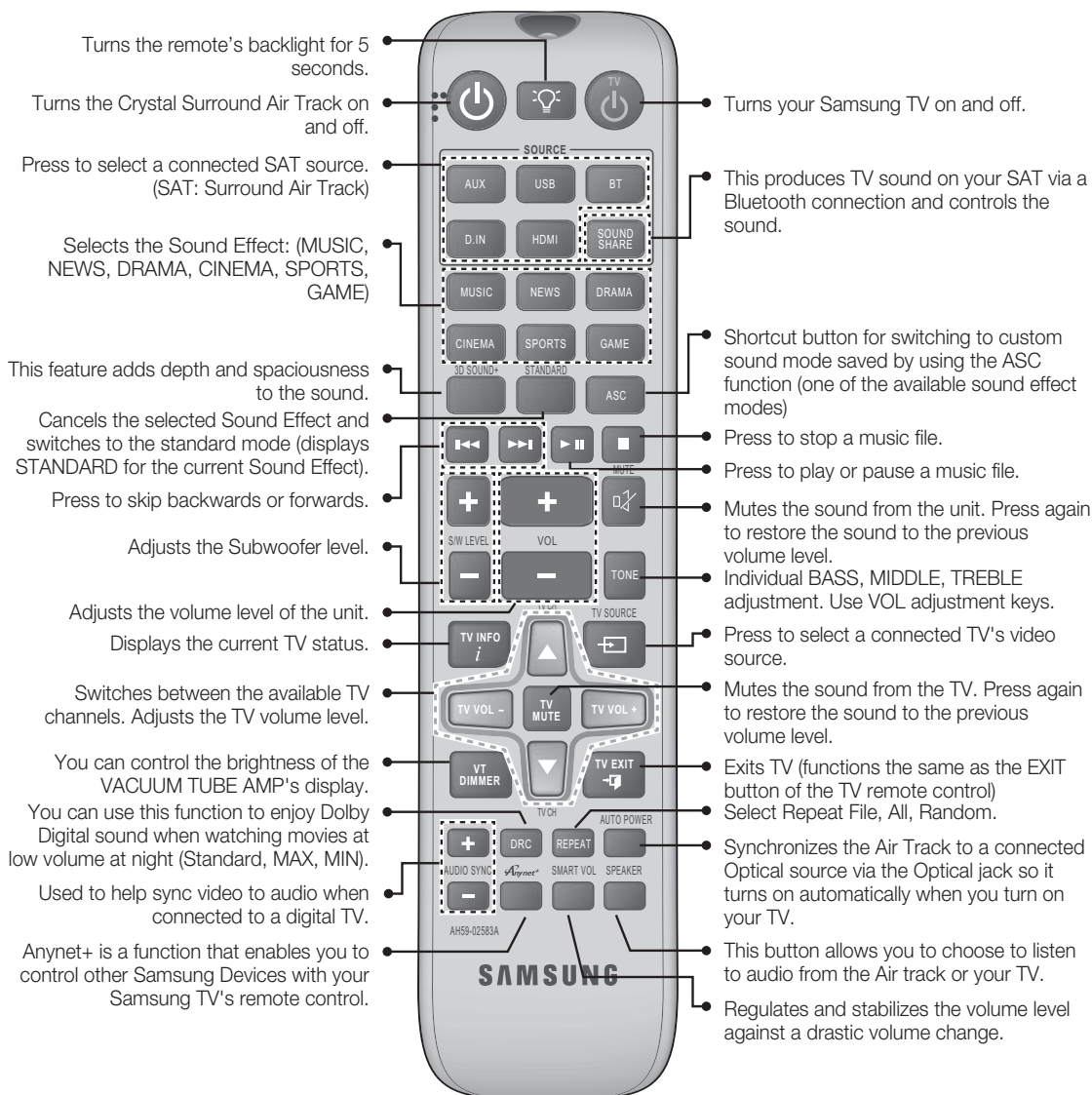

- SAT stands for Surround Air Track, which is a Samsung's proprietary name.
- The remote control can operate TVs made by SAMSUNG only.
- Depending on the TV you are using, you may not be able to operate your TV with this remote control. If you can't, operate the TV using the TV's remote control.

### Installing Batteries in the Remote Control

- Make sure to match the "+" and "-" ends of the batteries with the diagram inside the compartment.
- Assuming typical TV usage, the batteries last for about one year.
- You can use the remote control up to 23 feet (7 meters) in a straight line from the unit. You can also operate the remote at a horizontal angle of up to 30° from the remote control sensor.

Battery size: AAA

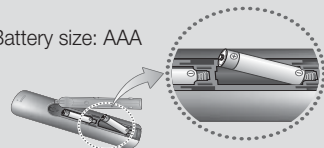

# connections

## INSTALLING THE WALL MOUNT

You can use the wall mount bracket to mount this unit on a wall.

### Installation Precautions

- Install on a vertical wall only.
- For the installation, avoid a location with high temperature or humidity, or a wall that cannot sustain the weight of the set.
- Check the strength of the wall. If the wall is not strong enough to support the unit, reinforce the wall or install the unit on a different wall that can support the unit's weight.
- Purchase and use the fixing screws or anchor appropriate for the kind of wall you have (plaster board, iron board, wood, etc.). If possible, fix the support screws into wall studs.
- Connect cables from the unit to external devices before you install it on the wall.
- Make sure the unit is turned off and unplugged before you install it. Otherwise, it may cause an electric shock.

1. Place the wall mount bracket on a wall surface and then secure it with two screws. If you are hanging the unit below a TV, be sure to install the wall mount bracket so that the arrow (↑) is placed in the center of the TV. Also make sure the unit is at least two inches (5 cm) below the TV.

2. Align the two HOLDER-SCREWS (screw holders) with the screw holes on the left and right sides of the MAIN UNIT, and then fix them to the main unit with the supplied screws.

3. Fit the unit into the corresponding slots of the wall mount bracket. For secure installation, make sure the mounting studs slide firmly down into the bottom of the slots.

4. The installation is complete.

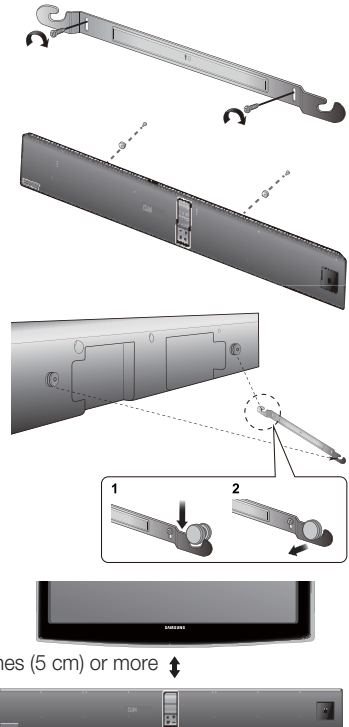



- Do not hang onto the installed unit and avoid striking or dropping the unit.
- Secure the unit firmly to the wall so that it does not fall off. If the unit falls off, it may cause an injury or damage the product.
- When the unit is installed on a wall, please make sure that children do not pull any of the connecting cables, as it may cause it to fall.
- For the optimal performance of a wall mount installation, install the speaker system at least 2 inches (5 cm) below the TV.
- For your safety, if you do not mount the unit on the wall, install it on a secure, flat surface where it is unlikely to fall.

## CONNECTING THE WIRELESS SUBWOOFER

The Subwoofer's linking ID is preset at the factory and the main unit and subwoofer should link (connect wirelessly) automatically when the main unit and subwoofer are turned on. If the **LINK** indicator does not light when the main unit and subwoofer are turned on, please set the ID by following the procedure below. Complete this process within 30 seconds after the Link Indicator on the subwoofer starts blinking.

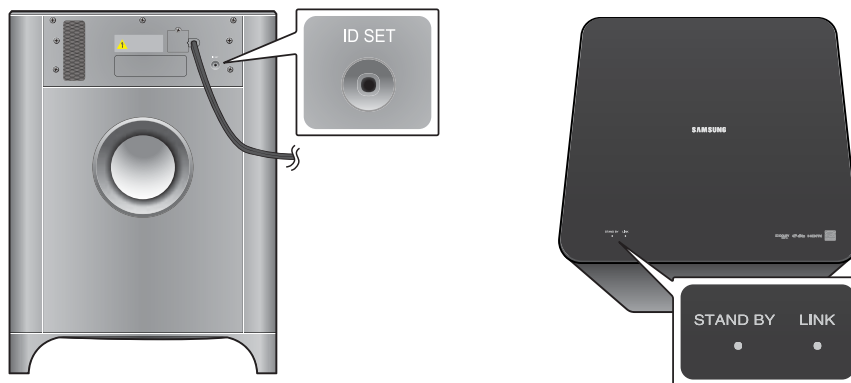
1. Plug the power cords of the main unit and subwoofer into an AC wall outlet.
2. Confirm that the main unit is off (in STANDBY Mode).
3. Press the **ID SET** button on the back of the subwoofer with a small, pointed object for 5 seconds.
  - The **LINK INDICATOR** (Blue LED) on the subwoofer blinks quickly.



4. While the main unit is powered off (in STANDBY mode), press and hold the **MUTE** (  ) on the remote control for 5 seconds.
5. The **ID SET** message appears on the main unit's OLED display.
6. To finalize the link, turn the main unit's power on while the subwoofer's LINK LED blinks.
  - The main unit and the subwoofer should now be linked (connected).
  - The LINK indicator (blue LED) on the subwoofer should be turned on and solid blue.
  - If the LINK indicator is not solid blue, the linking process has failed. Turn off the main unit and start again from Step 2.
  - You can enjoy better sound from the wireless subwoofer by selecting the a sound effect. (See page 24)

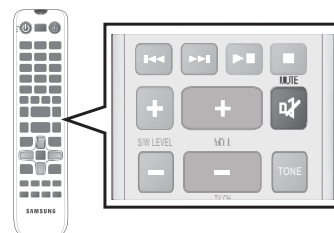

- Before moving or installing the product, be sure to turn off the power and disconnect the power cord.
- If the main unit is powered off, the wireless subwoofer will be in the standby mode and the STANDBY LED on the upper side will come on after the LINK indicator (Blue LED) blinks for 30 seconds.
- If you use a device that uses the same frequency (2.4GHz) as the unit near the unit, interference may cause some sound interruption.
- The transmission distance of the wireless signal between the main unit and subwoofer is about 33 ft., but may vary depending on your operating environment. If a steel-concrete or metallic wall is between the main unit and the wireless subwoofer, the system may not operate at all, because the wireless signal cannot penetrate metal.
- If the main unit doesn't make a wireless connection, follow steps 1-5 above to retry the connection between the main unit and wireless subwoofer.



- The wireless receiving antenna is built into the wireless subwoofer. Keep the unit away from water and moisture.
- For optimal listening performance, make sure that the area around the wireless subwoofer location is clear of any obstructions.

# connections

## ATTACHING THE TOROIDAL FERRITE CORE TO THE POWER CORD OF THE SUBWOOFER

Attaching the Toroidal ferrite core to the power cord of the subwoofer helps prevent RF interference from radio signals.

1. Pull the fixing tab of the Toroidal ferrite core to open it.
2. Make two loops around the core with the power cable of the subwoofer. See the illustration below.
3. Attach the Toroidal ferrite core to the Subwoofer power cord as shown in the illustration below, and then press it until it clicks.

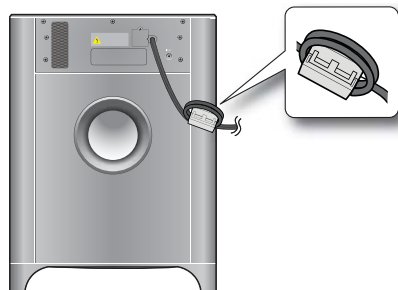

## LOOPING THE POWER CABLE AROUND THE TOROIDAL CORE

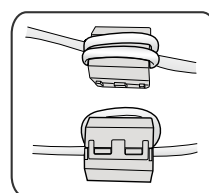
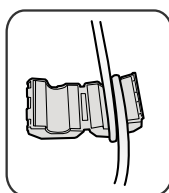
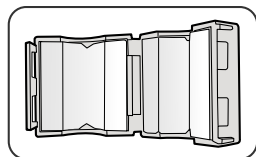
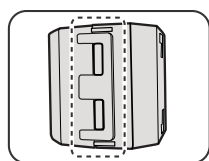

Lift up to release the lock and open the core.

Make two loops around the core with the power cable. (Start winding 5 to 10 cm [2 - 4 in.] away from the core).

Close the lock.

## AUTO SOUND CALIBRATION (ASC)

The ASC function measures the distance between the Air Track main unit, sub woofer, and your listening position and calibrates the volume levels and frequency characteristics of the main unit and sub woofer to provide optimum sound.

1. Place the ASC Microphone at the listening position.
  - You should place the ASC Microphone at the actual listening location first, and then connect the ASC Microphone to the **ASC IN** jack on the Air Track for precise calibration.
2. Connect the ASC Microphone to the **ASC IN** jack on the Air track. The Calibration starts automatically and takes about 2 minutes.
  - If you turn off the Air Track or unplug the ASC microphone before the completion message appears on the display, calibration will be cancelled and incomplete. If this occurs, plug the ASC microphone into the ASC IN jack again.
  - After calibration has been completed the first time, you can re-run the calibration process. Place the **ASC** microphone at the listening position, insert the ASC Microphone plug into the ASC jack, and then select the ASC mode by pressing the **Sound Effect** button on the remote control.

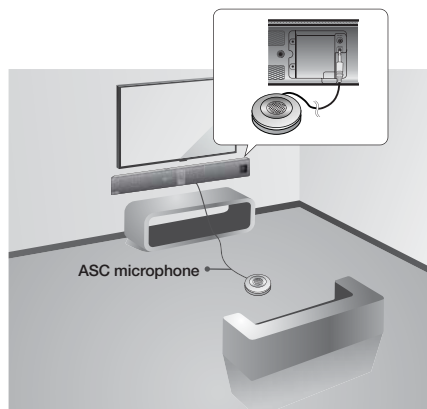

- During the ASC calibration, no other buttons work except the power button.
- ASC will abort with an error if you change the set's position in the middle of the ASC calibration.

## CONNECTING AN EXTERNAL DEVICE USING AN HDMI CABLE

HDMI is the standard digital interface for connecting to such devices as a TVs, projectors, DVD players, Blu-ray players, set top boxes, and more.

Because HDMI transmits the highest quality digital signal, you can enjoy superior video and audio - as it was originally created at the digital source.

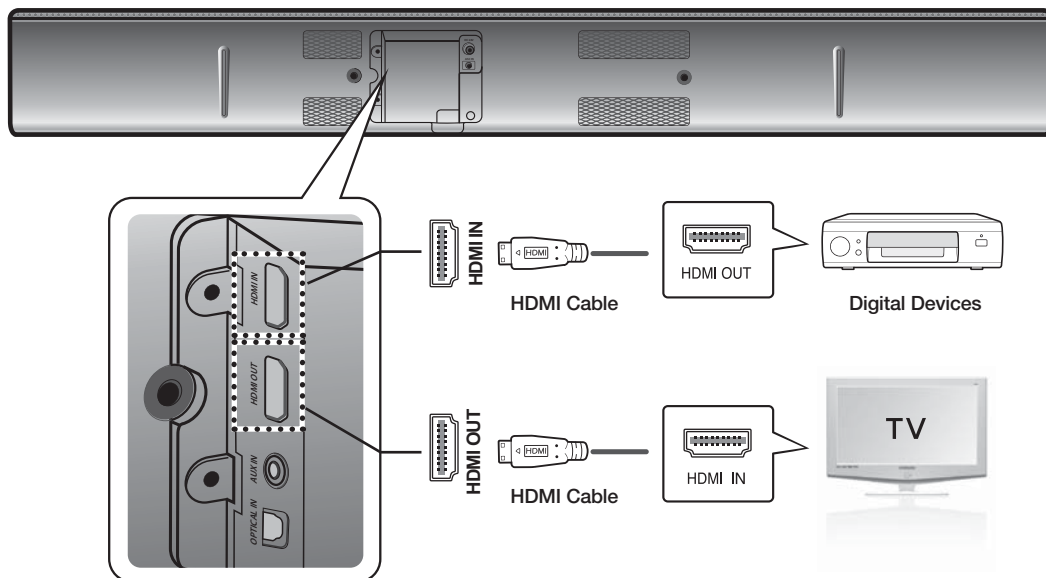

### HDMI IN

Connect an HDMI cable (not supplied) from the HDMI IN jack on the back of the product to the HDMI OUT jack on your digital devices.

and,

### HDMI OUT (HDMI)

- Connect an HDMI cable from the HDMI OUT jack on the back of the product to the HDMI IN jack on your TV.



- HDMI transmits digital video and audio signals through a single cable.

# connections

## CONNECTING AN EXTERNAL DEVICE USING AUDIO (ANALOG) CABLE OR OPTICAL (DIGITAL) CABLE

This unit comes equipped with one optical in digital jack and one audio analog in jack, giving you two ways to connect it to a TV.

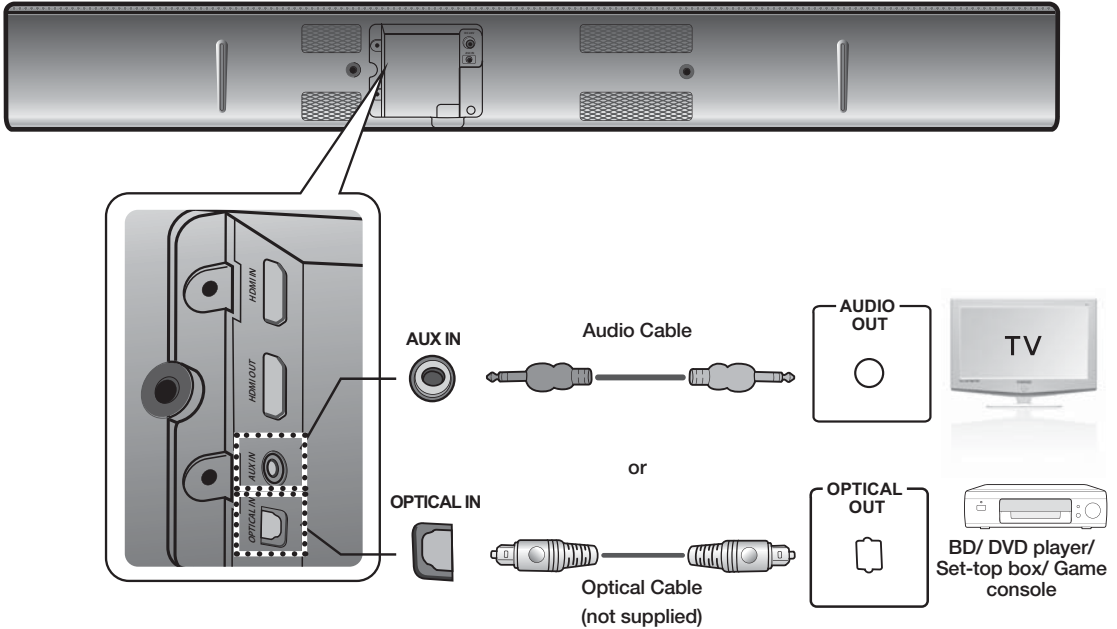

### AUX IN

Connect AUX IN (Audio) on the main unit to the AUDIO OUT of the TV or Source Device. Be sure to match connector colors.

or,

### OPTICAL IN

Connect the Digital Input on the main unit to the OPTICAL OUT of the TV or Source Device.



- Do not connect the power cord of this product or your TV to the wall outlet until all connections between components are complete.
- Before moving or installing this product, be sure to turn off the power and disconnect the power cord.

## ASSEMBLING THE CABLE CLIP

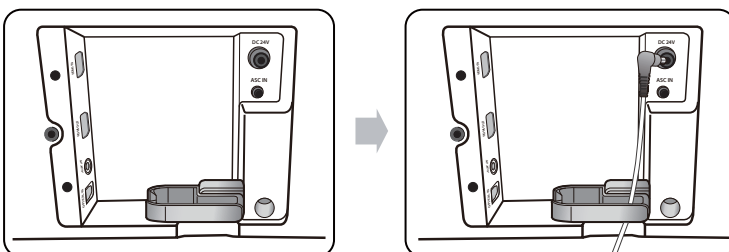

Attach the cable clip to the unit as shown, and then run the cables through the clip to keep them neat.

# functions

## INPUT MODE

You can select D.IN, AUX, HDMI, BT, TV input or USB input.

Press an appropriate button on the remote control to select a desired mode, or press **Source** repeatedly to select from D.IN, AUX, HDMI, BT, TV or USB mode.

Input mode	Display
<b>Optical Digital input</b>	D.IN
<b>AUX input</b>	AUX
<b>HDMI input</b>	HDMI
<b>BLUETOOTH mode</b>	BT
<b>TV mode</b>	TV
<b>USB mode</b>	USB

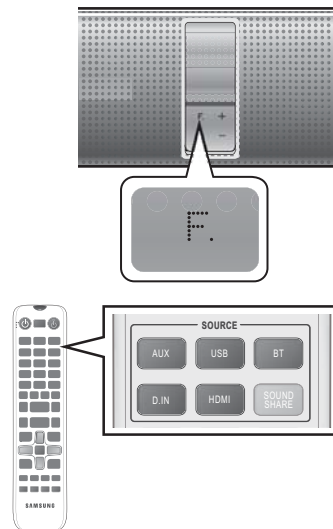

The unit turns off automatically in the following situations:

- BT/TV/USB/HDMI/ARC/D.IN MODE
  - If there is no audio signal for 20 minutes.
- AUX Mode
  - If there is no KEY input for 8 hours when the AUX cable is connected.
  - If the AUX cable is disconnected for 20 minutes.



- Use the provided cable if you cannot connect a USB flash memory device directly to the unit.

## ARC (HDMI OUT)

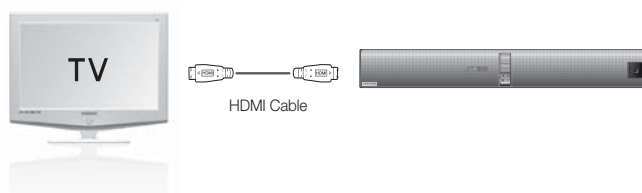

- The ARC function allows digital audio to output via the HDMI OUT (ARC) port. It can be enabled only when the Air Track is connected to a TV that supports the ARC function.
- Anynet+ must be turned on.



- This function is not available if the HDMI cable does not support ARC.
- The ARC function is activated in D.IN mode if you have connected the unit to a TV that supports ARC.
- To turn off the ARC function, turn Anynet off.

# functions

---

## NFC

---

Connect your NFC compatible device via Bluetooth to the AirTrack using this simple set-up procedure and play music on the device through the AirTrack.

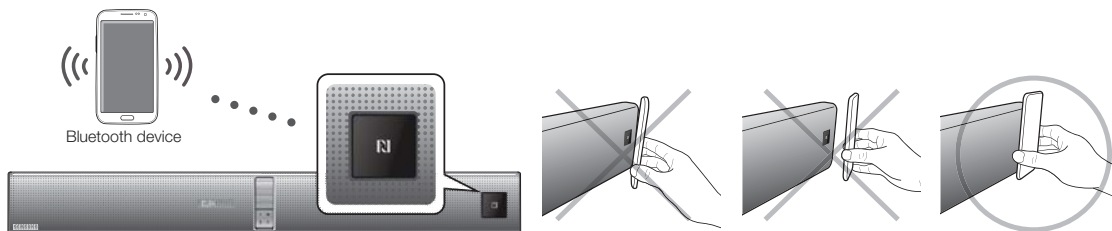

1. Turn on the NFC function on the device and make sure the screen lock function on the device is off. The device's NFC function will not work if screen lock is on.
2. Gently touch the NFC logo on the front of the AirTrack with the NFC supported device.
3. A pop-up asking whether to proceed with the Bluetooth connection appears on the device. Select **<Yes>**.
  - When the connection is complete, the 'connected' message appears.
4. To disconnect the NFC device, gently touch the device to the NFC logo on the front of the AirTrack again. To connect another NFC device while the first device is still connected, touch the device to the NFC logo on the front of the AirTrack. The AirTrack will disconnect the first device and connect the second device.



- **Warning:** NFC pairing may not be successful if you do not place your NFC device on the Airtrack correctly. If you see an "Empty tag" error message on your mobile device, you must gently touch your NFC device to the Airtrack again and be sure you match the NFC location on your mobile device to the NFC logo on the Airtrack exactly.
- The NFC function is built into Android devices running Android OS 4.1.2 Jellybean or later.
  - If your mobile device has Android OS 4.1.2 Jellybean or later, it must also have an NFC tag to run the NFC function. See the instructions of your device for details.
  - If your device has an Android OS earlier than Android OS 4.1.2 Jellybean, your device must have an NFC tag and you must download the 'Samsung NFC Connection' application from Android market to run the NFC function.
- The position of the NFC antenna differs on devices. Check where the NFC antenna is located before connecting.
- If your device is covered with a thick case, the connection may not succeed.
- The N-mark is a trademark or registered trademark of NFC Forum, Inc. in the United States and in other countries.



## BLUETOOTH

You can use a Bluetooth device to enjoy music with high quality stereo sound, all without wires!

### What is Bluetooth?

Bluetooth is a technology that enables Bluetooth-compliant devices to interconnect easily with each other using a short wireless connection.

- A Bluetooth device may cause noise or malfunction, depending on usage, when:
  - A part of your body is in contact with the receiving/transmitting system of the Bluetooth device or the Air Track.
  - It is subject to electrical variation from obstructions caused by a wall, corner, or office partition.
  - It is exposed to electrical interference from same frequency-band devices including medical equipment, microwave ovens, and wireless LANs.
- Pair the Air Track with the Bluetooth device while they are close together.
- The further the distance between the Air Track and Bluetooth device, the worse the quality is. If the distance exceeds the Bluetooth operational range, the connection is lost.
- In poor reception-sensitivity areas, the Bluetooth connection may not work properly.
- The Bluetooth connection only works when it is close to the unit. The connection will be automatically cut off if the Bluetooth device is out of range. Even within range, the sound quality may be degraded by obstacles such as walls or doors.
- This wireless device may cause electric interference during its operation.

### To connect the Air Track to a Bluetooth device

Check if the Bluetooth device supports the Bluetooth compliant stereo headset function.

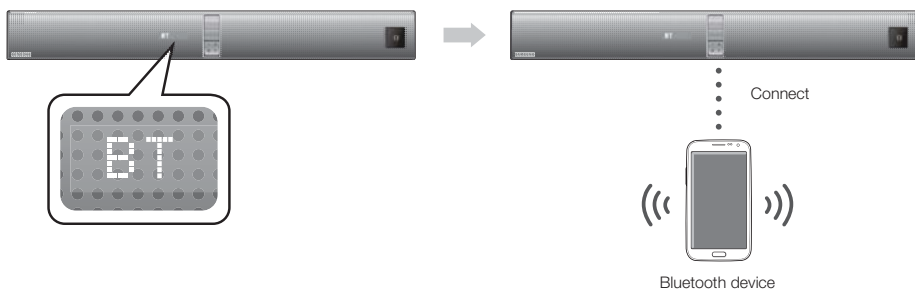

1. Press the **BT** button on the remote control of the AirTrack to display the **BT** message.
  - The message **WAIT** appears at the very first Bluetooth activation after powering on. From the next activation, **BT READY** will appear.
2. Select the Bluetooth menu on the Bluetooth device you want to connect. (Refer to the Bluetooth device's user manual.)
3. Select the Stereo headset menu on the Bluetooth device.
  - You will see a list of scanned devices.
4. Select "[Samsung] AirTrack" from the list.
  - When the Air Track is connected to the Bluetooth device, it will display **BT CONNECTED → BT** on the front display.
  - If the Bluetooth device has failed to pair with the Air Track, delete the previous "[Samsung] AirTrack" found by the Bluetooth device and have it search for the Air Track again.
5. Play music on the connected device.
  - You can listen to the music playing on the connected Bluetooth device over the Crystal Surround Air Track system.
  - In BT mode, the Play/Repeat/Stop/Next/Prev functions are not available.



- You may be required to enter a PIN code (password) when connecting the Bluetooth device to the Air Track. If the PIN code input window appears, enter <0000>.
- The Airtrack only supports Middle Quality SBC data (up to 237kpps@48kHz). It does not support High Quality SBC data (328kpps@44.1kHz).
- The AVRCP feature is not supported.
- Connect only to a Bluetooth device that supports the A2DP (AV) function.
- You cannot connect to a Bluetooth device that supports only the HF (Hands Free) function.
- Only one Bluetooth device can be paired at a time.
- Once you have turned off Air Track and the pairing is disconnected, the pairing will not be restored automatically. To reconnect, you must pair the device again.
- Search or connection may not be performed properly by Air Track in the following cases:
  - If there is a strong electrical field around the Air Track.
  - If several Bluetooth devices are simultaneously paired with AirTrack.
  - If the Bluetooth device is turned off, not in place, or malfunctions.
  - Note that such devices as microwave ovens, wireless LAN adaptors, fluorescent lights, and gas stoves use the same frequency range as the Bluetooth device, which can cause electric interference.

---

## To disconnect the Bluetooth device from the Air Track

---

You can disconnect the Bluetooth device from the Air Track. For instructions, see the Bluetooth device's user manual.

- The Air Track will be disconnected.
- When the Air Track is disconnected from the Bluetooth device the Air Track will display **BT DISCONNECTED** on the front display.

---

## To disconnect the Air Track from the Bluetooth device

---

Press the (F) button on the front panel of the Air Track to switch from BT to another mode or turn off the Air Track.

- The connected Bluetooth device will wait a certain amount of time for a response from the Air Track before terminating the connection. (Disconnection time may differ, depending on the Bluetooth device)
- The currently connected device will be disconnected.



- In Bluetooth connection mode, the Bluetooth connection will be lost if the distance between the Air Track and the Bluetooth device exceeds 16.25 ft. (5m).
- If the Bluetooth device comes back into the effective range after disconnecting, you can restart the Air Track to restore the pairing with the Bluetooth device.
- The Air Track automatically turns off after 20 minutes in the Ready state.

## SOUNDSHARE

This section explains how to connect the Crystal Surround Air Track to a Bluetooth compatible SAMSUNG TV.

### To connect the Crystal Surround Air Track to a Bluetooth compatible Samsung TV

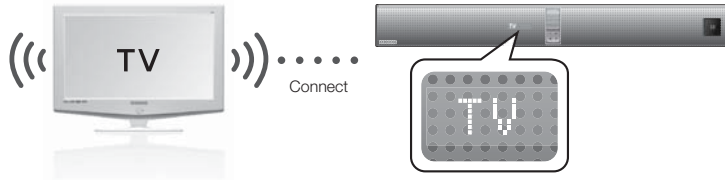

Press the (  ) on the front panel of the Air Track or the Sound Share button on the remote to select the TV mode, and then connect the TV to the Crystal Surround Air Track.

- The unit will play the TV's audio when it is connected to the TV.
- If you change to another mode, except the TV SoundShare mode, or turn off the Air Track, you will hear audio from the TV again.

#### <To pair to your TV>

To produce TV sound on your Air Track via a Bluetooth connection, you need to pair your system to the Bluetooth compliant TV first. Once the pairing is established, the pairing information is recorded and kept and no further Bluetooth connection message will appear. Bring the Air Track and the TV close together before pairing.

1. Turn on the Samsung TV and Air Track.
  - Set Add New Device in the TV's SoundShare Setting menu to On.
2. When you change the mode of the Air Track to **TV**, a message asking whether to proceed with Bluetooth pairing is displayed. "[Samsung] AirTrack" appears on the TV screen.
3. Select **<Yes>** on the TV screen. The pairing with the Air Track will be completed.
  - Once the pairing is established, when you change the Air Track to the TV mode from other input modes, it will automatically connect to the TV.
  - Changing the Air Track from TV mode to any other mode will cancel the SoundShare connection.
  - If you want to cancel the existing pairing of the SAT to a TV and pair your SAT to a different TV.
    - Press the **PLAY /PAUSE** button on the SAT for 5 seconds in the TV input mode to cancel the existing pairing. You can now pair it to a different TV.
  - In the SoundShare mode, you can control the volume and mute using either the TV remote or the SAT remote.



- TV SoundShare operation range
  - recommended pairing range: within 20 inches (within 50cm)
  - recommended operation range: within 16.25 ft. (5m)
- If the distance between the Air Track and Samsung TV is over 16.25 ft. (5m), the connection or the sound can be cut off. If this occurs, connect to the Bluetooth device again within the operational range.
- Make sure the Samsung TV's SoundShare mode is on before you use this function.
- The **PLAY, NEXT, PREV, STOP** buttons will not work in the SoundShare mode.
- Bluetooth Standby On function
  - The Air Track will be powered on automatically when you turn the TV on if you connected the TV and Air Track with SoundShare function.
  - You can toggle this function On/Off by pressing the **SoundShare** button for more than 5 seconds when the AirTrack is powered off. If set to Off, the product turns off automatically when the TV turns off, but it does not turn on automatically.
  - This feature is supported by TVs released from 2013 on.
- The SoundShare feature is supported by select models released from 2012 on. Check whether your TV supports SoundShare before you begin. (For more information, refer to the user's guide of your TV.)

# functions

## USB

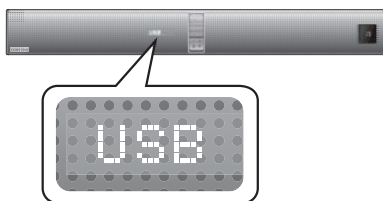

1. Connect the USB device to the USB port of the product.
2. Press the (F) button on the front panel of the Air Track repeatedly until **USB** appears.
3. **USB** appears on the display screen and then disappears.
  - The Crystal Surround Air Track connection is complete.
  - The SAT automatically turns off (Auto Power Off) if no USB device has been connected for more than 20 minutes.



- Playback will stop if you change the unit's position while playing files from a USB device.

### Before you connect a USB device

Be aware of the following:

- If the file name of a folder on a USB device exceeds 10 characters, it is not displayed on the OLED.
- This product may not be compatible with certain types of USB storage media.
- The Air Track supports the FAT16 and FAT32 file systems.
  - The NTFS file system is not supported.
- Connect USB devices directly to the USB port of the product. Otherwise, you may encounter a USB compatibility problem.
- Do not connect multiple storage devices to the product via a multi-card reader. It may not operate properly.
- Digital camera PTP protocols are not supported.
- Do not remove the USB device while it is being read.
- DRM-protected music files (MP3, WMA) from a commercial web site will not be played.
- External HDDs are not supported.
- Mobile phone devices are not supported.
- File Format Type Compatibility list:

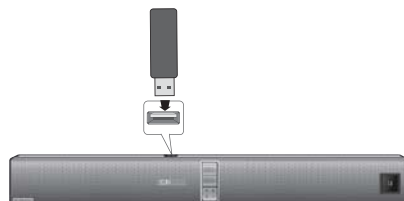

Format	Codec
*.mp3	MPEG 1 Layer2
	MPEG 1 Layer3
	MPEG 2 Layer3
*.wma	Wave_Format_MSAudio1
	Wave_Format_MSAudio2
*.aac	AAC
	AAC-LC
	HE-AAC
*.wav	-
*.Ogg	OGG 1.1.0
*.Flac	FLAC 1.1.0, FLAC 1.2.1

※ Supporting Sampling Rate above 16KHz

## USING THE REMOTE CONTROL

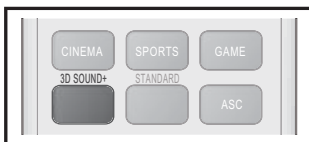

### Play/Pause/Stop

During playback, press the ►||,■ button.

- Press the ►|| button again to stop playing the file temporarily. Press the ►|| button to play the selected file.
- To stop playback, press the Stop (■) button during playback.

### Skip Forward/Back

During playback, press the ◀◀,▶▶ button.

- When there is more than one file and you press the ▶▶ button, the next file is selected.
- When there is more than one file and you press the ◀◀ button, the previous file is selected.

### Using the REPEAT function

Repeat playback allows you to repeatedly play a file, repeat all, randomly play files, or turn Repeat off.

Press the **REPEAT** button.

- **REPEAT OFF** : Cancels Repeat Playback.
- **REPEAT FILE** : Repeat playing a track.
- **REPEAT ALL** : Repeat playing all tracks.
- **REPEAT RANDOM** : Plays tracks in random order. (A track that has already been played may be played again.)



- You can set the REPEAT function during music playback from a USB drive.

### Muting the sound

This is useful when answering a doorbell or telephone call.

1. To mute the sound of this unit, press the **MUTE** (🔇) button on the remote control.
2. To mute the TV, press the **TV MUTE** button on the remote control.
3. Press **MUTE** (🔇) / **TV MUTE** on the remote control again (or press **VOLUME** (+) / (-) to restore the sound.

### Using the TONE function

Press **TONE** on the remote control.

- Each time the button is pressed, the selection changes as follows :  
TREBLE ➔ MIDDLE ➔ BASS



- Use the VOL button to adjust the setting to -6 ~ +6.

### Using the 3D SOUND PLUS function

The 3D Sound Plus feature adds depth and spaciousness to the sound.

Press **3D SOUND PLUS** on the remote control.

- Each time the button is pressed, the selection changes as follows :  
3D SOUND PLUS OFF ➔ 3D SOUND PLUS MUSIC ➔ 3D SOUND PLUS MOVIE



- When you turn on 3D Sound Plus, the Sound Effect function will automatically change to STANDARD.

# functions

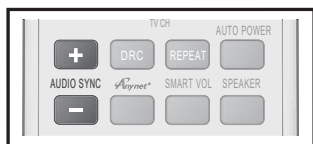

## Using the SMART VOL function

This will regulate and stabilize the volume level against a drastic volume change caused by a channel change or scene transition.

Press **SMART VOL** on the remote control.

- Each time the button is pressed, the selection changes as follows :  
SMART VOLUME ON ➔ SMART VOLUME OFF

## Using the S/W LEVEL function

You can control the base volume with the **S/W LEVEL** button on the remote control.

1. Press an **S/W LEVEL** button on the Remote control.
2. “**SW 0**” appears on the display.
3. Press **+** or **-** button on the **LEVEL** key if you want to increase or decrease the subwoofer volume. You can set it from SW -6 to SW +6.

## Using the AUTO POWER LINK function

The Crystal Surround Air Track is automatically turned on when you turn on the TV or any device connected to the Air Track with the optical cable.

Press **AUTO POWER** on the remote control of this unit.

- The Auto power link function turns on and off each time you press **AUTO POWER**.

AUTO POWER LINK	Display
ON	POWER LINK ON
OFF	POWER LINK OFF



- If a TV or any device connected to Air Track with the optical cable is off and there is no digital input, the Air Track is turned off after 20 minutes.
- These functions are available only when the Anynet+ (HDMI-CEC) is turned off.

## Using the AUDIO SYNC function

Video may appear out of synch with the audio if the Air Track is connected to a digital TV. If this occurs, adjust the audio delay time to match the video.

Press **AUDIO SYNC** **+** / **-** on the remote control of this unit.

- You can use the **+**, **-** buttons to set the audio delay time between 0 ms and 300 ms.



- In USB mode, TV mode or BT mode, the Audio Sync function may not work.

## Using the DRC function

This feature balances the range between the loudest and quietest sounds. You can use this function to enjoy Dolby Digital sound when watching movies at low volume at night.

Press **DRC** on the remote control of this unit.

- Each time the button is pressed, the selection changes as follows :  
DRC STANDARD ➔ DRCMAX ➔ DRCMIN

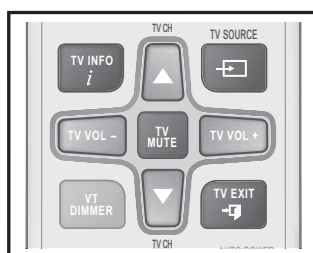
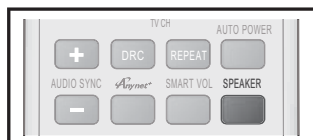

## Using the VT DIMMER function

This feature controls the brightness of the VACUUM TUBE AMP.

Press **VT DIMMER** on the remote control of this unit.

- Each time the button is pressed, the selection changes as follows :  
VT DIMMER OFF ➔ VT DIMMER MIN ➔ VT DIMMER MAX



- The VT DIMMER does not function for 30 seconds when you turned on the product for the very first time.

## SPEAKER button

If a TV and the Air Track are connected via HDMI, this button lets you select between listening to audio through your TV or through the Air Track.

Press **SPEAKER** on the remote control of this unit.

AUDIO MODE	SPEAKER	Scroll Display	Display
HDMI IN	TV	TV SPEAKER	TV SPK
	Air Track	AVR SPEAKER	HDMI
ARC	TV	TV SPEAKER	S MUTE
	Air Track	AVR SPEAKER	TV ARC

## Using the Anynet+(HDMI-CEC) function

Anynet+ is a function that enables you to control other Samsung Devices with your Samsung TV's remote control.

The Anynet+ function turns on and off each time you press **Anynet+**.

- Connect the product to a Samsung TV with an HDMI cable. (See page 13)
- Set the Anynet+ function on your TV and the SAT to ON. (See the TV instruction manual for more information.)



- Depending on your TV, certain HDMI output resolutions may not work.
- Please refer to the user's manual of your TV and check for the **Anynet+** logo (If your TV has an **Anynet+** logo, then it supports the Anynet+ function.)

## Using the TV functions (with Samsung TVs only)

- Press **TV SOURCE** on the remote control to change the TV's input source.
- Press **TV INFO** on the remote control to display the TV channel information.
- Press **TV CH** on the remote control to select the TV channel.
- Press **TV VOL** on the remote control to increase or decrease the volume level.
- To exit the TV menu, use the **TV EXIT** button. (It functions the same as the EXIT button of the TV remote control.)



- When you press the **SOUNDSHARE** button, the TV's sound is transmitted through the Air Track system via a Bluetooth connection. The Air Track also controls the sound volume, sound quality, etc.
- The remote control can operate TVs made by SAMSUNG only.

# functions

---

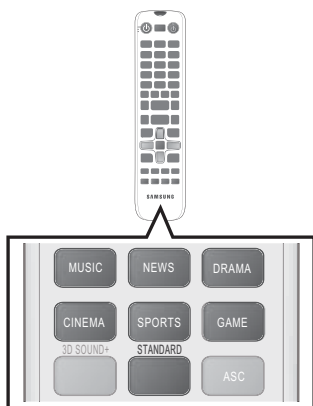

## Using the Sound Effect function

---

You can select from 7 different sound modes - MUSIC, NEWS, DRAMA, CINEMA, SPORTS, GAME and STANDARD (Original Sound) - depending on the type of sources you want to enjoy.

Press **MUSIC, NEWS, DRAMA, CINEMA, SPORTS, GAME** on the remote control.

- Select the **STANDARD** mode if you want to enjoy the original sound.



- We recommend that you select a Sound Effect based on the source material and your personal taste.
- When you choose a Sound Effect mode (except STANDARD), 3D Sound Plus will automatically be turned OFF.
- Once ASC calibration is completed, the ASC mode will be added.

## SOFTWARE UPGRADE

---

Samsung may offer upgrades for the Crystal Surround Air Track's system firmware in the future.

If an upgrade is offered, you can upgrade the firmware by connecting a USB drive with the firmware upgrade stored on it to the USB port on your Air Track.

Note that if there are multiple upgrade files, you must load them onto the USB drive singly and use them to upgrade the firmware one at a time.

Please visit [Samsung.com](http://Samsung.com) or contact the Samsung call center to receive more information about downloading upgrades files.

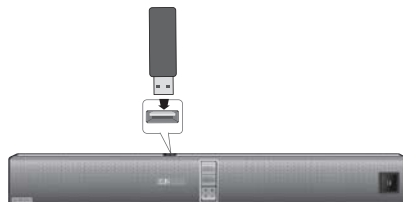

- Insert a USB drive containing the firmware upgrade into the USB port on the main unit.
- Do not disconnect the power or remove the USB drive while upgrades are being applied. The main unit will turn off automatically after completing the firmware upgrade.  
When software is upgraded, settings you have made will return to their default (factory) settings.  
We recommend you write down your settings so that you can easily reset them after the upgrade.
- Once the software upgrade is completed, turn off the product and then press and hold the (■) button for a while to reset the product.
- If the firmware fails to upgrade, we recommend formatting the USB device in FAT16 and trying again.
- For upgrading purposes, do not format the USB drive in NTFS format because it is not a supported file system.
- Depending on the manufacturer, some USB devices may not be supported.



# troubleshooting

Before requesting service, please check the following.

Symptom	Check	Remedy
<b>The unit will not turn on.</b>	<ul style="list-style-type: none"> <li>Is the power cord plugged into the outlet?</li> </ul>	<ul style="list-style-type: none"> <li>Connect the power plug to the outlet.</li> </ul>
<b>A function does not work when the button is pressed.</b>	<ul style="list-style-type: none"> <li>Is there static electricity in the air?</li> </ul>	<ul style="list-style-type: none"> <li>Disconnect the power plug and connect it again.</li> </ul>
<b>Sound is not produced.</b>	<ul style="list-style-type: none"> <li>Is the unit properly connected to your TV?</li> <li>Is the Mute function on?</li> <li>Is the volume set to minimum?</li> </ul>	<ul style="list-style-type: none"> <li>Connect it correctly.</li> <li>Press the Mute button to cancel the function.</li> <li>Adjust the volume.</li> </ul>
<b>The Picture does not appear on a TV when the function is selected.</b>	<ul style="list-style-type: none"> <li>Is the TV connected properly?</li> </ul>	<ul style="list-style-type: none"> <li>Connect it correctly</li> </ul>
<b>The remote control does not work.</b>	<ul style="list-style-type: none"> <li>Are the batteries drained?</li> <li>Is the distance between the remote control and main unit too far?</li> </ul>	<ul style="list-style-type: none"> <li>Replace with new batteries.</li> <li>Move closer to the unit.</li> </ul>
<b>The sound from the left/right channels are reversed.</b>	<ul style="list-style-type: none"> <li>Are the left/right audio output cables from the TV connected properly?</li> </ul>	<ul style="list-style-type: none"> <li>Check the left/right channel and connect it/them correctly.</li> </ul>
<b>The SoundShare (TV pairing) failed.</b>	<ul style="list-style-type: none"> <li>Does your TV support SoundShare?</li> <li>Is your TV firmware the latest version?</li> <li>Does an error occur when connecting?</li> <li>Reset the TV MODE and connect again.</li> </ul>	<ul style="list-style-type: none"> <li>SoundShare is supported by some Samsung TVs released after 2012. Check your TV to see if it supports SoundShare.</li> <li>Update your TV with the latest firmware.</li> <li>Contact the Samsung call center.</li> <li>Press ►   button for 5 seconds to reset the product.</li> </ul>

# appendix

## SPECIFICATIONS

<b>Model name</b>		HW-F850	
<b>GENERAL</b>	Power supply	Main unit	DC 24V
		Subwoofer (PS-WF850)	AC 120V~60Hz
	Standby power consumption		0.45W
	Power consumption	Main unit	36W
		Subwoofer (PS-WF850)	20W
	USB		5V/0.5A
	Weight	Main unit	8.82 lbs
		Subwoofer (PS-WF850)	23.15 lbs
	Dimensions (W x H x D)	Main unit	46.54 x 4.96 x 2.25 inches
		Subwoofer (PS-WF850)	12.01 x 15.81 x 12.01 inches
Operating temperature range		+41°F to +95°F	
Operating humidity range		10 % to 75 %	
<b>AMPLIFIER</b>	Rated output power	Main Front	50W/CH, 4OHM, THD = 1%, 1kHz
		Main Top	50W/CH, 4OHM, THD = 1%, 1kHz
		Subwoofer (PS-WF850)	150W, 3OHM, THD = 10%, 100Hz
	S/N ratio (analog input)		65 dB
	Separation (1kHz)		65 dB

\* S/N ratio, distortion, separation and usable sensitivity are based on measurement using AES (Audio Engineering Society) guidelines.

\* Nominal specification

- Samsung Electronics Co., Ltd reserves the right to change the specifications without notice.
- Weight and dimensions are approximate.



As an ENERGY STAR Partner, Samsung has determined that this product or product models meets the ENERGY STAR guidelines for energy efficiency.

# WARRANTY

---

## LIMITED WARRANTY TO ORIGINAL PURCHASER

This SAMSUNG brand product, as supplied and distributed by Samsung Electronics America, Inc. (SAMSUNG) and delivered new, in the original carton to the original consumer purchaser, is warranted by SAMSUNG against manufacturing defects in materials and workmanship for a limited warranty period of:

### **One (1) Year Parts and Labor\*** **(\*90 Days Parts and Labor for Commercial Use)**

This limited warranty begins on the original date of purchase, and is valid only on products purchased and used in the United States. To receive warranty service, the purchaser must contact SAMSUNG for problem determination and service procedures. Warranty service can only be performed by a SAMSUNG authorized service center. The original dated bill of sale must be presented upon request as proof of purchase to SAMSUNG or SAMSUNG's authorized service center. Transportation of the product to and from the service center is the responsibility of the purchaser.

SAMSUNG will repair or replace this product, at our option and at no charge as stipulated herein, with new or reconditioned parts or products if found to be defective during the limited warranty period specified above. All replaced parts and products become the property of SAMSUNG and must be returned to SAMSUNG. Replacement parts and products assume the remaining original warranty, or ninety (90) days, whichever is longer.

SAMSUNG's obligations with respect to software products distributed by SAMSUNG under the SAMSUNG brand name are set forth in the applicable end user license agreement. Non-SAMSUNG hardware and software products, if provided, are on an "AS IS" basis. Non-SAMSUNG manufacturers, suppliers, publishers, and service providers may provide their own warranties.

This limited warranty covers manufacturing defects in materials and workmanship encountered in normal, and except to the extent otherwise expressly provided for in this statement, noncommercial use of this product, and shall not apply to the following, including, but not limited to: damage which occurs in shipment; delivery and installation; applications and uses for which this product was not intended; altered product or serial numbers; cosmetic damage or exterior finish; accidents, abuse, neglect, fire, water, lightning or other acts of nature; use of products, equipment, systems, utilities, services, parts, supplies, accessories, applications, installations, repairs, external wiring or connectors not supplied and authorized by SAMSUNG, or which damage this product or result in service problems; incorrect electrical line voltage, fluctuations and surges; customer adjustments and failure to follow operating instructions, cleaning, maintenance and environmental instructions that are covered and prescribed in the instruction book; product removal or reinstallation; reception problems and distortion related to noise, echo, interference or other signal transmission and delivery problems. SAMSUNG does not warrant uninterrupted or error-free operation of the product.

THERE ARE NO EXPRESS WARRANTIES OTHER THAN THOSE LISTED AND DESCRIBED ABOVE, AND NO WARRANTIES WHETHER EXPRESS OR IMPLIED, INCLUDING, BUT NOT LIMITED TO, ANY IMPLIED WARRANTIES OF MERCHANTABILITY OR FITNESS FOR A PARTICULAR PURPOSE, SHALL APPLY AFTER THE EXPRESS WARRANTY PERIODS STATED ABOVE, AND NO OTHER EXPRESS WARRANTY OR GUARANTY GIVEN BY ANY PERSON, FIRM OR CORPORATION WITH RESPECT TO THIS PRODUCT SHALL BE BINDING ON SAMSUNG. SAMSUNG SHALL NOT BE LIABLE FOR LOSS OF REVENUE OR PROFITS, FAILURE TO REALIZE SAVINGS OR OTHER BENEFITS, OR ANY OTHER SPECIAL, INCIDENTAL OR CONSEQUENTIAL DAMAGES CAUSED BY THE USE, MISUSE OR INABILITY TO USE THIS PRODUCT, REGARDLESS OF THE LEGAL THEORY ON WHICH THE CLAIM IS BASED, AND EVEN IF SAMSUNG HAS BEEN ADVISED OF THE POSSIBILITY OF SUCH DAMAGES. NOR SHALL RECOVERY OF ANY KIND AGAINST SAMSUNG BE GREATER IN AMOUNT THAN THE PURCHASE PRICE OF THE PRODUCT SOLD BY SAMSUNG AND CAUSING THE ALLEGED DAMAGE. WITHOUT LIMITING THE FOREGOING, PURCHASER ASSUMES ALL RISK AND LIABILITY FOR LOSS, DAMAGE OR INJURY TO PURCHASER AND PURCHASER'S PROPERTY AND TO OTHERS AND THEIR PROPERTY ARISING OUT OF THE USE, MISUSE OR INABILITY TO USE THIS PRODUCT SOLD BY SAMSUNG NOT CAUSED DIRECTLY BY THE NEGLIGENCE OF SAMSUNG. THIS LIMITED WARRANTY SHALL NOT EXTEND TO ANYONE OTHER THAN THE ORIGINAL PURCHASER OF THIS PRODUCT, IS NONTRANSFERABLE AND STATES YOUR EXCLUSIVE REMEDY.

Some states do not allow limitations on how long an implied warranty lasts, or the exclusion or limitation of incidental or consequential damages, so the above limitations or exclusions may not apply to you. This warranty gives you specific legal rights, and you may also have other rights which vary from state to state.

To obtain warranty hardware service, please contact SAMSUNG customer care center.



QUESTIONS OR COMMENTS?

COUNTRY	CALL	OR VISIT US ONLINE AT	WRITE
U.S.A	1-800-SAMSUNG (726-7864)	<a href="http://www.samsung.com">www.samsung.com</a>	Samsung Electronics America, Inc. 85 Challenger Road Ridgefield Park, NJ 07660